

## AT88IP

### TS-over-IP

Receiver/Converter/Recorder  
DVB-T2/T/C to DVB-ASI & IP Converter

Pro-MPEG Code Of Practice #3(COP3) FEC



## Standard Features

### DVB-T2/T/C to IP & DVB-ASI Receiver, Recorder Converter.

- Receives DVB-T2/T/C TS & converts into ASI & IP in real time.
- Records TS using Free application DVStationIP.
- **Web based Software** as well as **DVStationIP**.
- **DVStationIP** runs on **Windows XP, Vista, Windows 7**.
- Remote Web-based configuration management.
- Remote firmware upgrade.
- Saved configuration settings.
- No re-configuration needed after system reboot.
- An alternative to dedicated satellite links.
- Connects digital video equipment to computer networks.
- Encapsulation of the TS data for Ethernet uses IP and the **UDP**, with **RTP** encapsulation and Pro-MPEG **COP3 FEC** as an option.
- Dedicated hardware performs the encapsulation, which maximizes the throughput and minimizes latency.

## Application

Targeted for Digital Video Professionals, Sophisticated End Users and OEMs the AT88IP is an ideal solution for a number of applications such as:

- Development Tools.
- **DVB to IP Gateway**.
- **Video on Demand Server**.
- Transport Stream Test Generator.
- **Studio to Transmitter Links**.
- **ENG** (Electronic News Gathering) Stream content to and from remote locations.
- ASI input to Cable System.
- Providing an ASI input for decoders, Multiplexers, Modulators.

## IP

- IP Maximum rate of up to 214 Mbps per ASI channel.
- Network jitter correction.
- Supports constant bit rate ASI output.
- IP address assignment from DHCP server & static IP.
- IP address also configurable through the web interface.
- Configuration for Time To Live (TTL) for Multicast.

### DVB-T2/T/C Input

- **RF Tuner Connector:** 75 Ohms IEC female Type.
- **Loop Through Connector:** 75 Ohms IEC male Type.

### Input Frequency Range:

- **High Band:** 434.0 MHz to 858.0 MHz.
- **Mid Band:** 149.5 MHz to 426.0 MHz.
- **Low Band:** 50.5 MHz to 142.5 MHz.
- **Channel Bandwidth:** 6, 7 & 8 MHz.
- **RF Sensitivity:** -80dBm
- **COFDM Spectrum (DVB-T2/T):**  
2k and 8k carriers non-hierarchical and hierarchical.
- **Modulation Modes:** DVB-T/T2: QPSK, 16QAM, 64QAM
- **Modulation Modes:** DVB-C: 64QAM, 128QAM, **256QAM**
- **Guard Interval Modes:** 1/4, 1/8, 1/16, 1/32.

## Specifications

### DVB-IP

- **Ethernet encapsulation:** IEEE 802.2 SNAP, Eth.
- **Encapsulation:** UDP or RTP
- **IP support:** IPv4
- **IP-address assignment:** DHCP link local or static
- **Multicast support:** IGMPv2
- **Date Rate:** 100/1000
- **GigE port Physical layer:** IEEE 802.3a
- **GigE port Connector:** RJ-45 with LEDs
- **FEC:** Pro-MPEG Code Of Practice #3(COP3)
- **TSoverIP to ASI latency:** Less than 1ms
- **Jitter tolerance range:** 500ms

### DVB-ASI

- **Port Physical layer:** EN50083-9
- **Connector:** 75 Ohms Mini BNC
- **Input Return Loss:** >15 dB.
- **Input Signal level:** 800 mV +/- 10%
- **Output Signal level:** 1.0Vp-p nominal.
- **Input/Output Bit Rate:** 0 to 214 Mbit/s.

### DVB-T2/T/C

- **Standards:** DVB-T2/T/C.

## 1 BLOCK DIAGRAM

The block diagram of the AT88IP device.

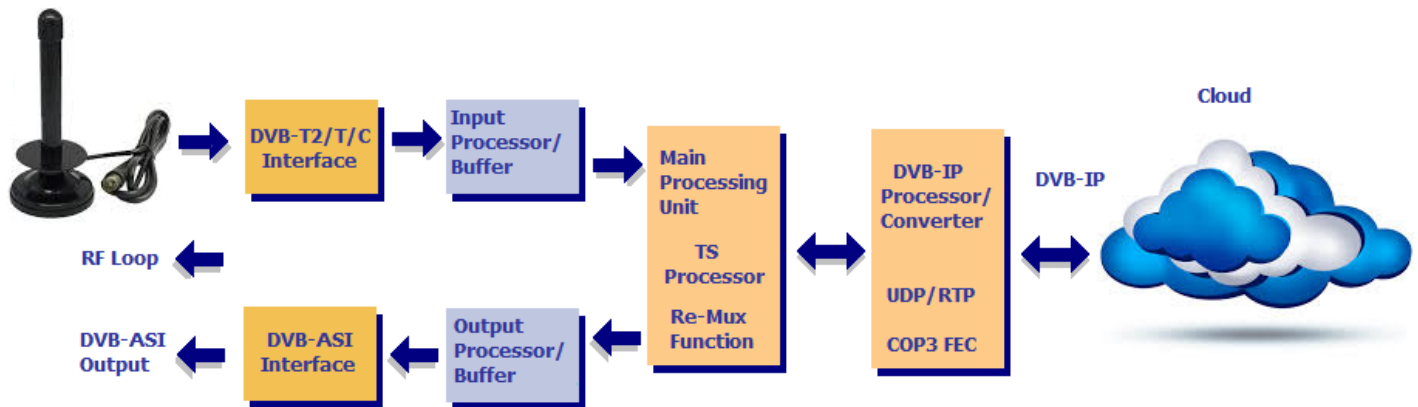

## 2 EXTERNAL INTERFACES

The external interfaces for the AT88IP are shown. There are two F-Type RF connectors, a Mini BNC connector for the DVB-ASI output, a RJ45 connector with two LEDs, a Power Supply Inlet and a Power Switch.

Only the power adaptor supplied by Alitronika with this device should be used. These power supplies are carefully selected for output voltage, current & power ratings as well as noise level. Using any other power supplies will affect the performance of the device for sure and may damage the device's internal components permanently which is not covered by the warranty.

The three LEDs in front of the unit function as follows:

### Top LED - Power

**ON** = Power is on

**OFF** = Power is off, No power

### Middle LED - Status1

**OFF** = After power up this LED should be Blinking, if not something is wrong!

**ON** = When the device has connected correctly with the IP Network.

### Bottom LED - Status2

**OFF** = This LED is off after power up

**ON** = When the device has SYNC to any incoming and/or out going TS.





### 3 INSTALLATION

The AT88IP device operates in a stand-alone mode. RF input & IP parameters are set using the Remote Web-based configuration management application. As such there are no need for any other application software. However DVStationIP, the IP version of Alitronika's DVStation3/4/IP application software is provided FREE of charge with these devices. Please follow these steps for problem free operation of the device.

#### Step 1: Application Software

Download the application software, DVStationIP, from our website.

Link : [www.alitronika.com/downloads.htm](http://www.alitronika.com/downloads.htm)

Unzip it & install it on a PC/Laptop.

#### Step 2: Starting for the first Time

Connect the AT88IP & the PC/laptop to your network **DHCP** server.

Connect the power adaptor & Power up the AT88IP using the switch on the rear of the unit.

You should see the Power LED is ON and the 2nd LED, Status1, is BLINKING.

Start DVStationIP.

From the top bar, **Device**, use "**Discover**" in order to find the IP address of AT60IP.

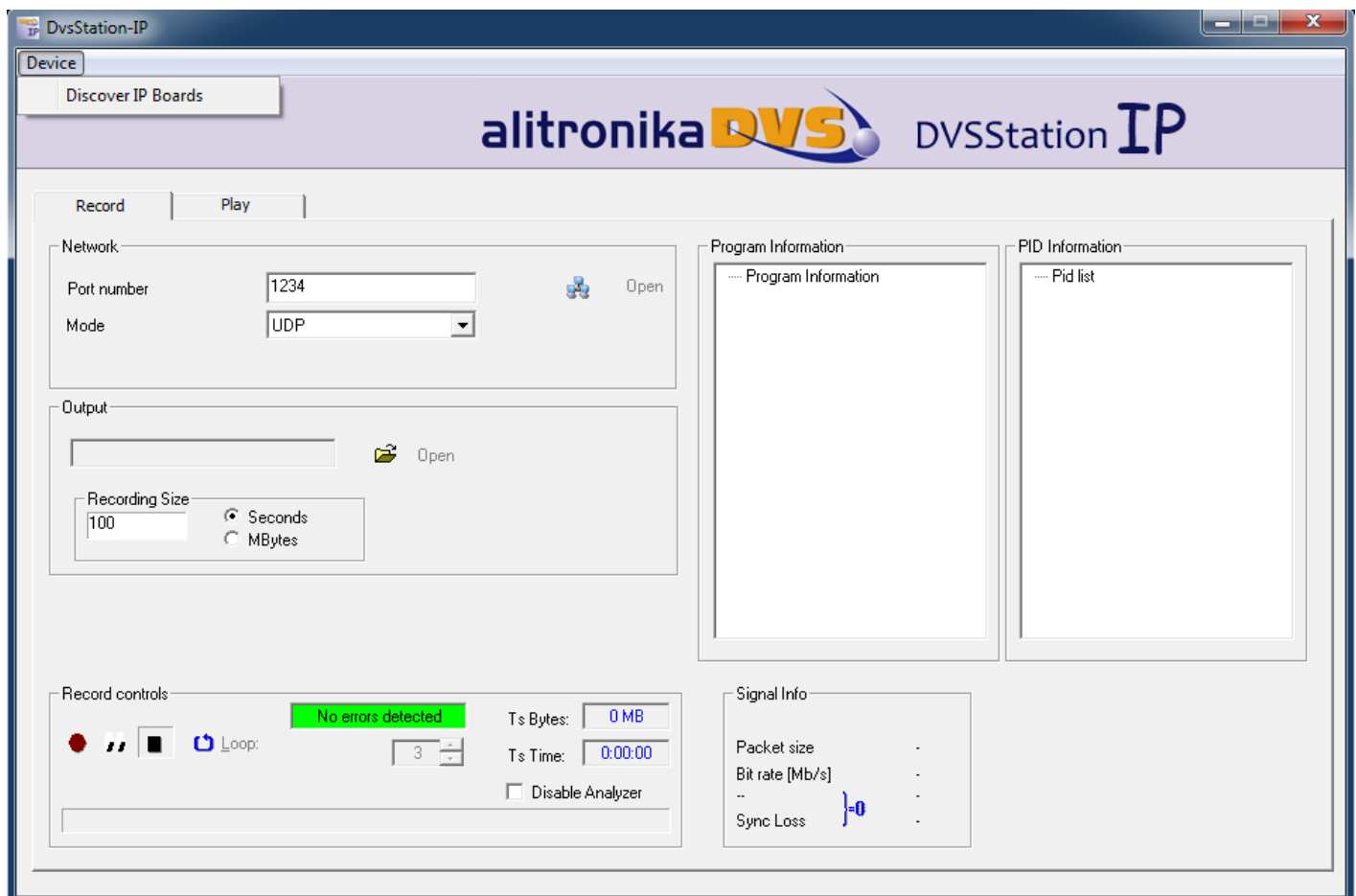

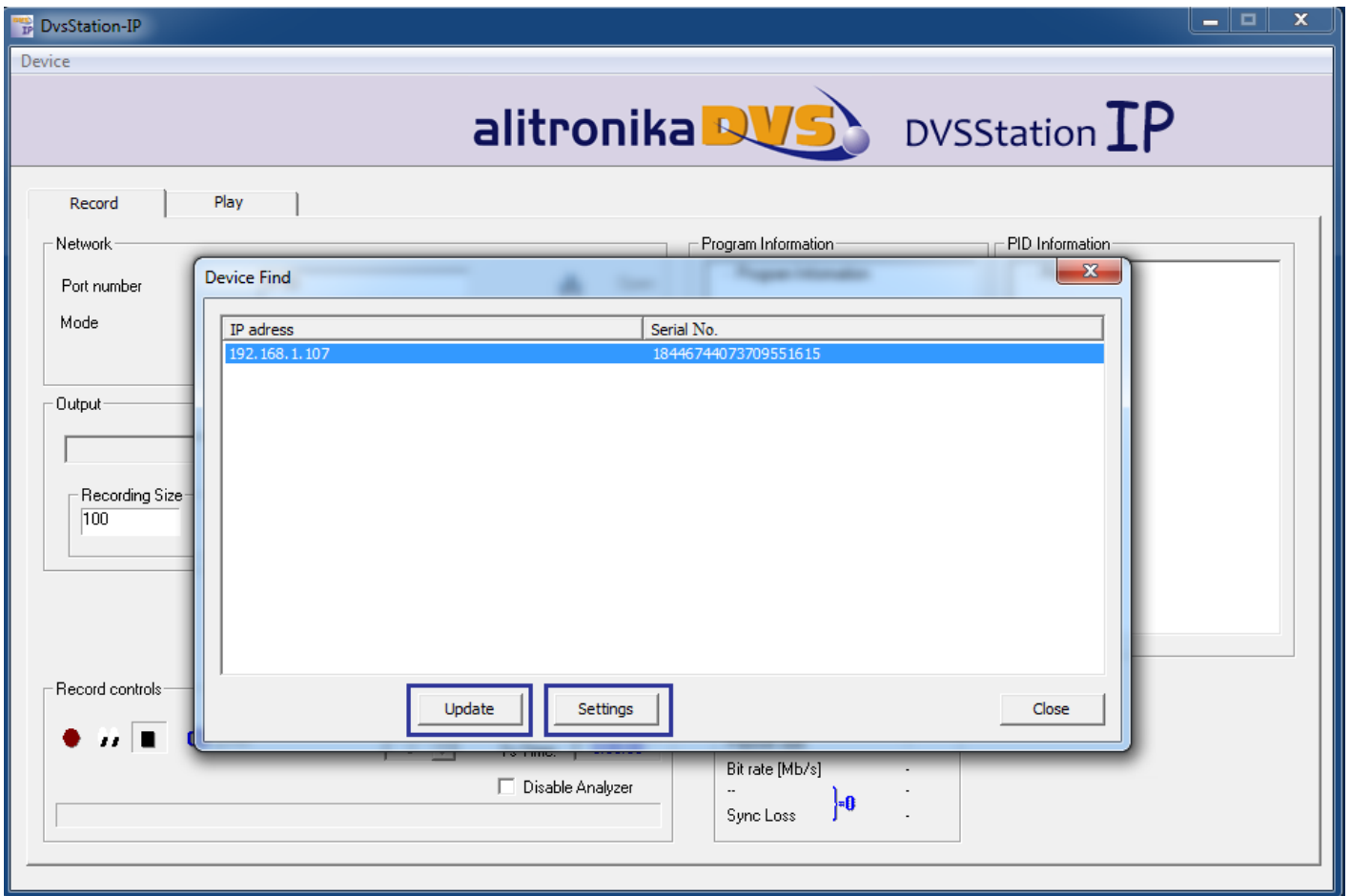

### Step 3: Updating the Firmware if needed

As shown on the screen shots, you should be able to see the IP address of the device as well as the serial number.

**Update** - Clicking on this would update the firmware of the AT88IP device.

You need not do this unless you really need an update. If your system is working OK just leave it.

If you do update the firmware you must wait for the **process to complete without any interruptions** for example, disconnecting the device from the network, powering it down. If the updating is interrupted the device will no longer have a valid firmware & no longer operates.

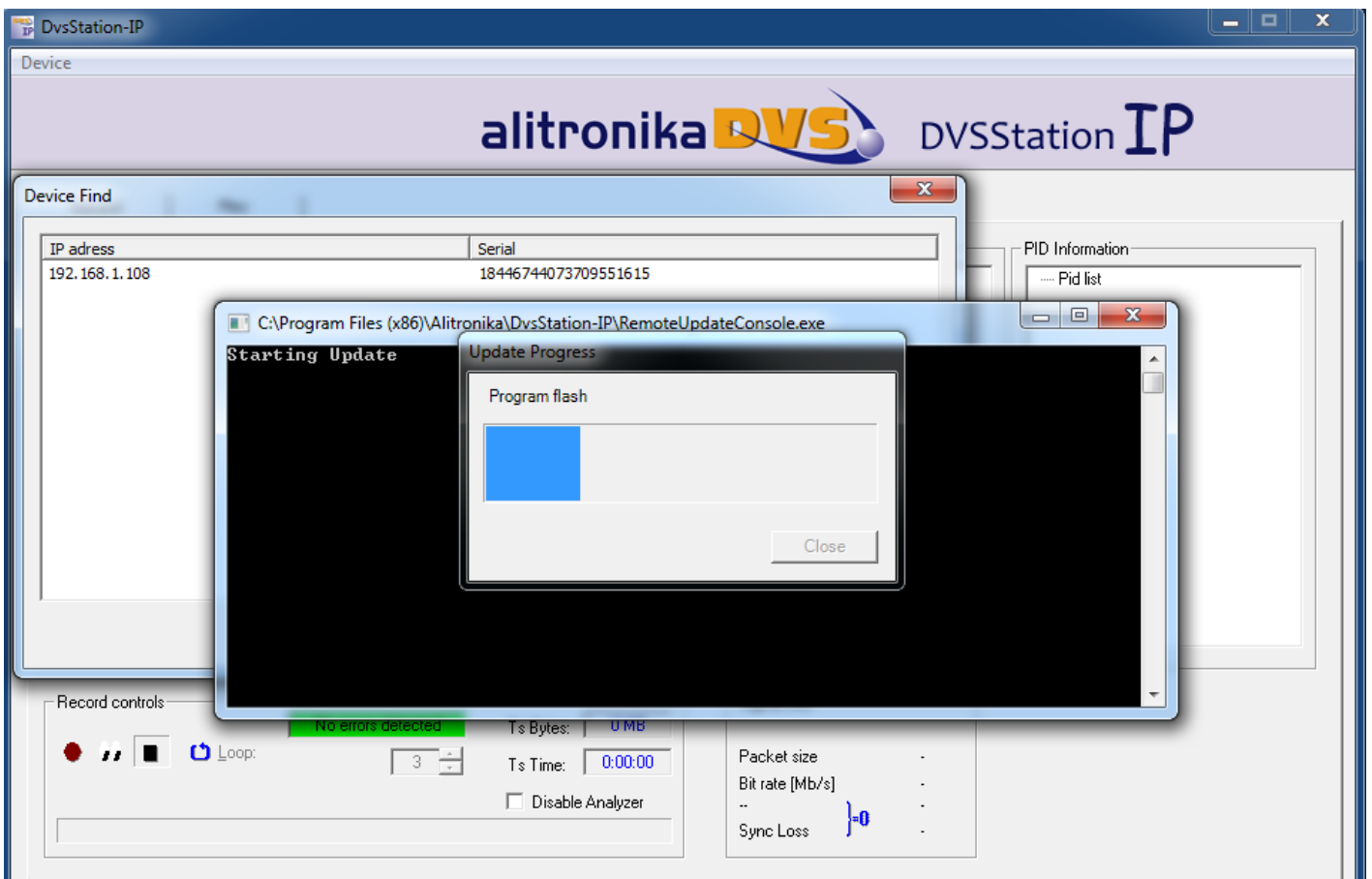

**Settings** - Clicking on this would start the Remote Web-based configuration management application on your web browser. Notice you could do this manually if you know the IP address by just typing this line on your web browser.

#### Step 4: Remote Web-based configuration management application

Once the configuration management starts this screen can be seen.

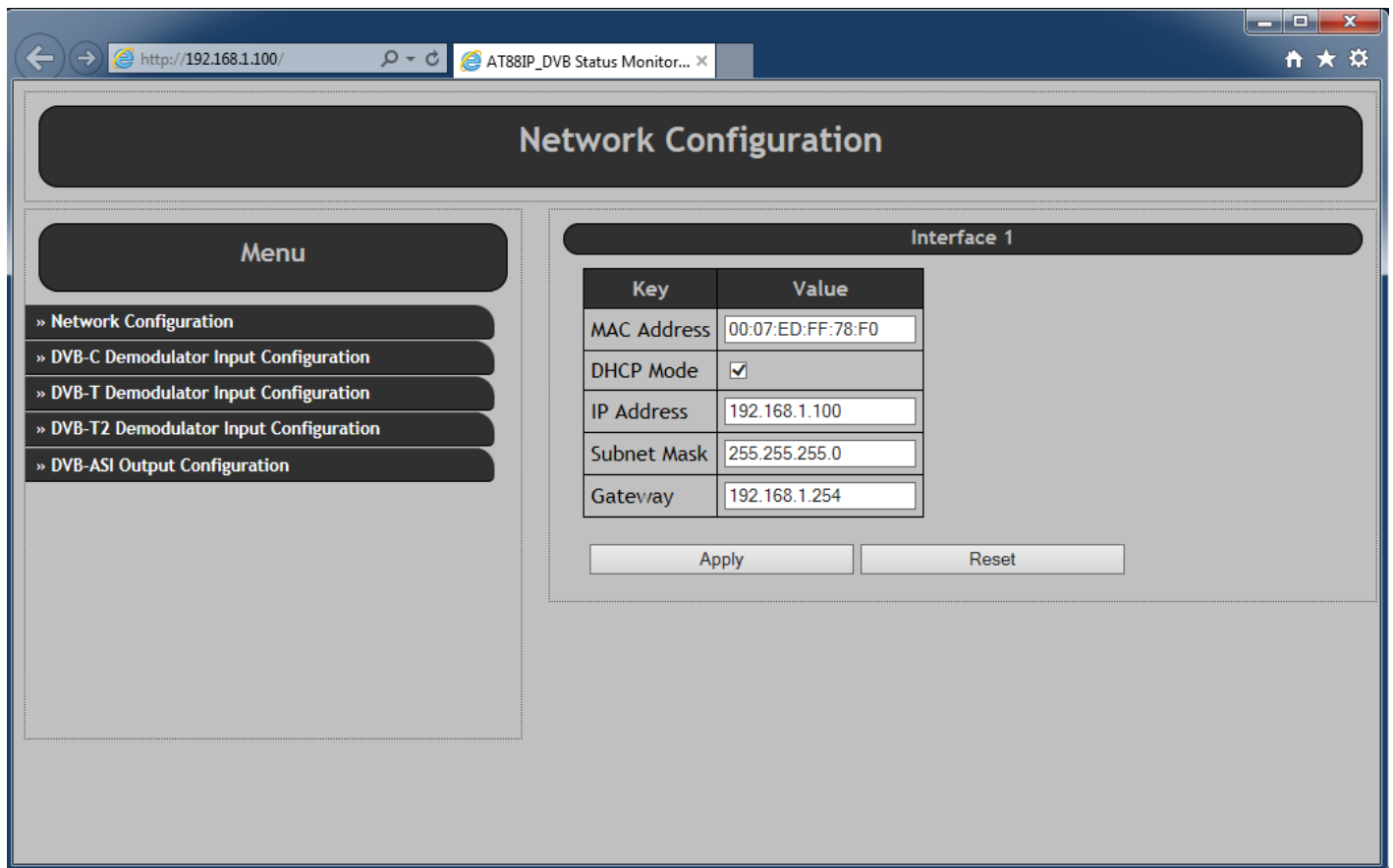

The "Network Configuration" screen is opened by default.

The MAC Address, IP Address, Subnet Mask & the Gateway address can be seen.

The user can change any of these & then clicking on "APPLY".

It is assumed the user is familiar with IP terms.

The DHCP Mode could be selected/De-selected.

## Step 5: Setting the DVB-T2/T/C De-modulator parameters.

As it can be seen from the screen shot below, in order for correct operation of the DVB-T2/T/C Receiver/Demodulator section, a few parameters must be set by the user.

**Notice the DVB-T2/T/C input port must first be ENABLED.**

**Selecting De-modulation mode:** The AT88IP has 3 modes, DVB-T2, DVB-T and DVB-C. The user can select any of these from the top level of Web-based configuration management application.

Once a mode ( T2, T or C ) is selected the following settings can be selected by the user.

- 1- **Demodulator Settings** - Here only two parameters need setting, the FREQUENCY & the BANDWIDTH for DVB-T and only the FREQUENCY settings for DVB-C.
- 2- **IP Encapsulation Settings**
  - 3.1- **Mode** – RTP or UDP
  - 3.2- **Packet Number** – Transport Packets are converted & send via IP in bursts. The number of packets per burst could be selected from 1 to 7. Refer to DVB over IP documents if you wish to know more about this. Also see Appendix1.
- 3- **Pro-MPEG FEC Settings**

Again it is assumed the user knows about DVB-over-IP.

It is clear when sending Transport Streams over IP ( or anything over IP ), data could get lost or corrupted. Forward Error Schemes such as Pro-MPEG Code Of Practice #3(COP3) FEC are used to recover the data. The user has control over the FEC.

FEC adds additional overhead to the data transfer over IP network.

  - 4.1- **Enabling the FEC** – User is able to Enable or Disable the FEC function. It is matter of trade-off between the speed & quality. We assume the user knows what is the best here.
  - 4.2- **Number of Columns & Rows ( L & C )** – Refer to DVB over IP for this. Also see Appendix1.
  - 4.3- **Interleaver Mode** - Refer to DVB over IP for this. Also see Appendix1.
- 4- **IP Settings** – The DVB-T2/T/C Transport Streams are Received, De-modulated & after being processed according to all of the user selected settings above, it send to IP address. The user has also control over where the streams are going.
  - 5.1- **Target IP Address** – Select an IP address for Unicast or select 255.255.255.255 for Multicast.
  - 5.2- **Target Port** – User can also select the port number.

Notes :

- Click on **Apply** to save the selected settings on the **non-volatile memory** of the AT60IP device. The device will operate with these parameters until the user changes them. No re-configuration needed after system reboot.

- All modulation parameters related to DVB-T2/T/C RF input and the incoming transport streams are detected automatically by the integrated TS Analyser. No user inputs are required.



http://192.168.1.100/#/ch0\_demo AT88IP\_DVB Status Monitor...

## DVB-T Demodulator Input Configuration

Settings saved

Menu

- » Network Configuration
- » DVB-C Demodulator Input Configuration
- » DVB-T Demodulator Input Configuration
- » DVB-T2 Demodulator Input Configuration
- » DVB-ASI Output Configuration

Key	Value
<b>Demodulator Settings</b>	
Enable	<input checked="" type="checkbox"/>
Frequency (Hz)	<input type="text" value="674000000"/>
Bandwidth	<input type="text" value="8 MHz"/>
<b>IP Encapsulation Settings</b>	
Mode	<input type="text" value="RTP"/>
Packet Count (1-7)	<input type="text" value="7"/>
<b>Pro-MPEG FEC Settings</b>	
Enable	<input type="checkbox"/>
L (Columns)	<input type="text" value="10"/>
D (Rows)	<input type="text" value="10"/>
Column Only	<input type="checkbox"/>
Interleaver mode	<input type="text" value="ANNEXB"/>
<b>IP Settings</b>	
Target IP address	<input type="text" value="255.255.255.255"/>
Target IP Port	<input type="text" value="9150"/>

RF Status	
Carrier Detected	YES
Locked	YES
Inverted	NO
SNR (dB)	23
Bit error rate	0

Demodulator mode Status	
Constellation	QAM64
Guard Interval	1/4
Hierarchy	NONE
Transmission mode	8K
Coderate High priority	1/2
Coderate Low priority	1/2

TS Bitrate Status	
DataCnt Locked	YES
DataCnt	14929472
PCR Locked	YES
PCR	14929428

TS Error Status	
Overflow error	NO
Data Errors	0
Sync Errors	0

## Step 6: Setting the DVB-ASI output parameters.

The DVB-ASI output of AT88IP is completely independent of the DVB-T2/T/C input.

This port is a device on its own.

It could be configured as follows :

- 1- It could be **turned off** altogether.
- 2- It can be **used as DVB-T2/T/C to DVB-ASI converter** to convert the incoming transport stream to be used for example as input of a decoder or a modulator. It could be used to monitor the incoming transport stream or any other function.
- 3- It could also be used as **an independent DVB-ASI output** of TS over IP converter.  
A completely different transport stream could be ported out of this output.  
Another use for it could for example be to port the input DVB-T2/T/C transport stream after some processing such as Multiplexing, Re-Multiplexing, PID filtering, Trans-coding, Logo inserting.  
In such a case the TS enters the system via the IP network, processing is carried out on it & is send out as a new transport stream via IP network to be used elsewhere in the system.

The screenshot shows a web browser window with the URL <http://192.168.1.107/> and the page title "AT88IP\_DVB Status Monit...". The main content area is titled "DVB-ASI Output Configuration".

On the left, there is a "Menu" section with the following options:

- » Network Configuration
- » DVB-C Demodulator Input Configuration
- » DVB-T Demodulator Input Configuration
- » DVB-T2 Demodulator Input Configuration
- » DVB-ASI Output Configuration

The main configuration area contains several tables:

Key	Value
<b>Output Settings</b>	
Output Mode	OFF DVB-IP Demodulator Loop
Remux Bitrate Enable	<input type="checkbox"/>
Remux Bitrate	40000000
Burst size	1
<b>IP Encapsulation Settings</b>	
Encapsulator mode	RTP
<b>IP Settings</b>	
Source IP Port	9150
Source IP Delay (ms)	500

Below the tables are "Apply" and "Reset" buttons.

<b>TS Status (DVB-IP mode only)</b>	
Carrier Detected	-
Locked	-
In Sync	-
Packet Size	-
<b>TS Bitrate (DVB-IP mode only)</b>	
DataCnt Locked	-
DataCnt	-
PCR Locked	-
PCR	-
<b>TS Error (DVB-IP mode only)</b>	
Overflow error	-
Data Errors	-
Sync Errors	-

## 4 APPLICATION SOFTWARE

AT88IP operates as a stand-alone device. DVStationIP could be used to add even more functions & features to it.

- 1- Up-dating the firmware
- 2- Finding the device's IP address with "Discover" function when not used with a fixed IP address.
- 3- Recording & monitoring the incoming transport stream.
- 4- Play back any transport streams

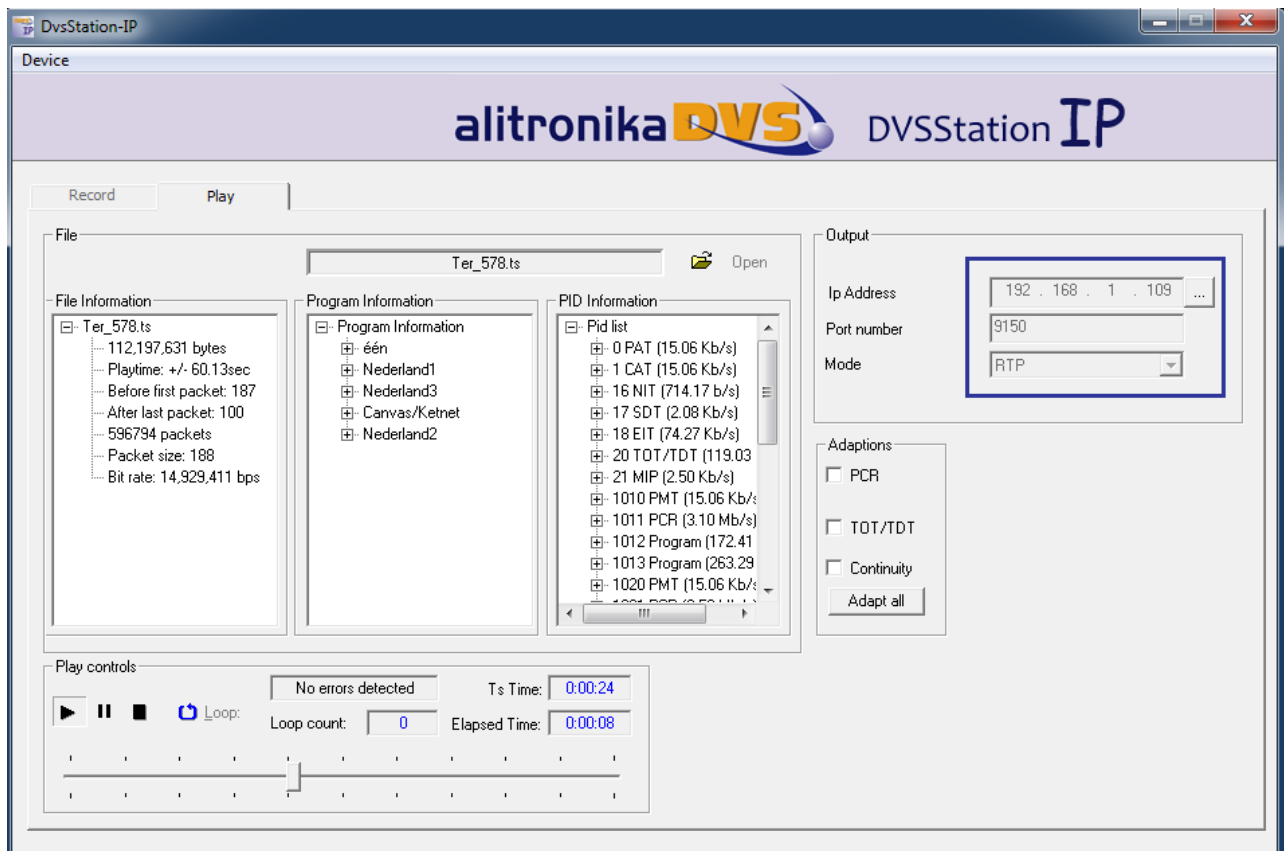
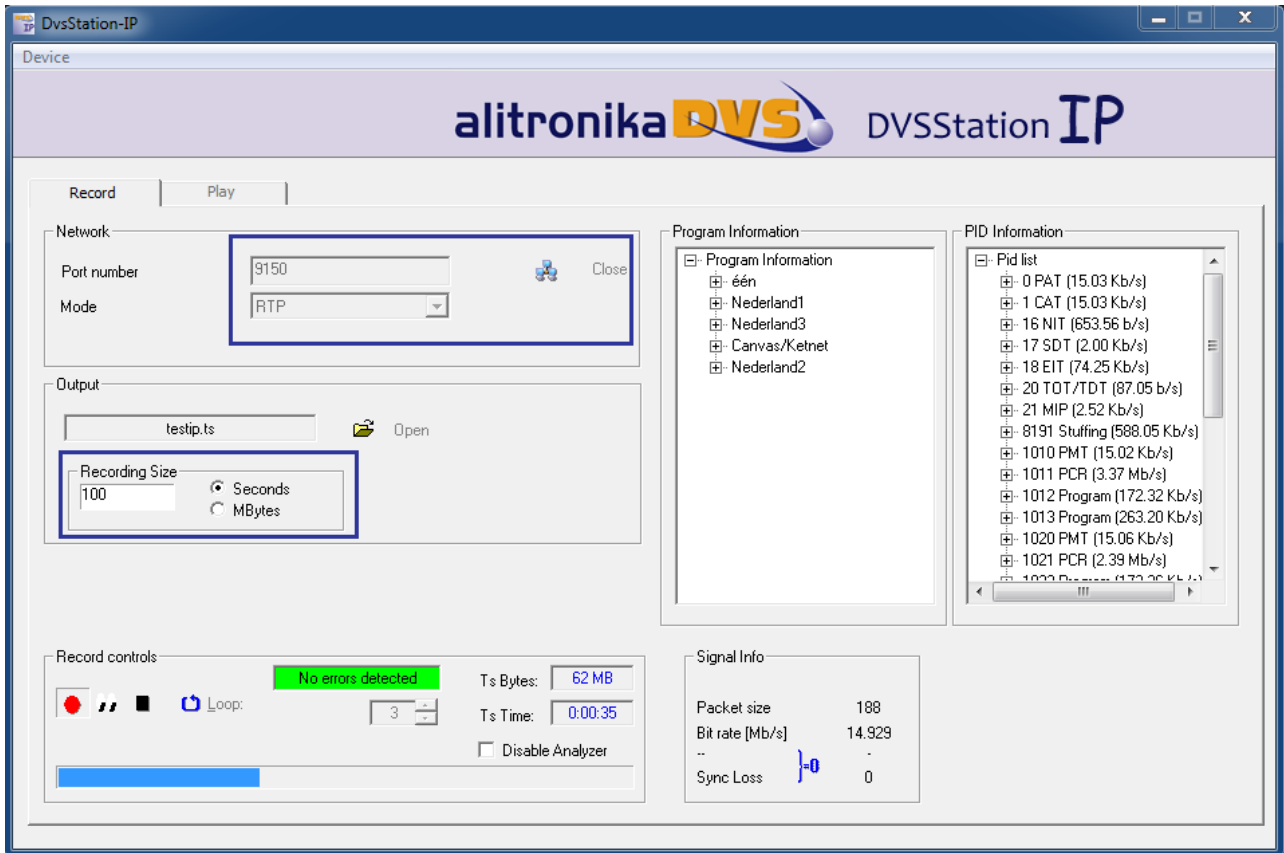

## 5 SOFTWARE DECODERS

In order to view the programs any software decoder could be used.

Most of them could be downloaded from the Internet FREE of charge.

One such software is the VideoLan. Use this like to download <http://www.videolan.org/>.

Once install on your system.

- From "Media" => Open Network Stream
- Type in "rtp://@:9150" for example ( if you are using RTP mode & the Port is 9150 )
- From "Playback"=> Click on "Programs" and select the desired program for the list to view.

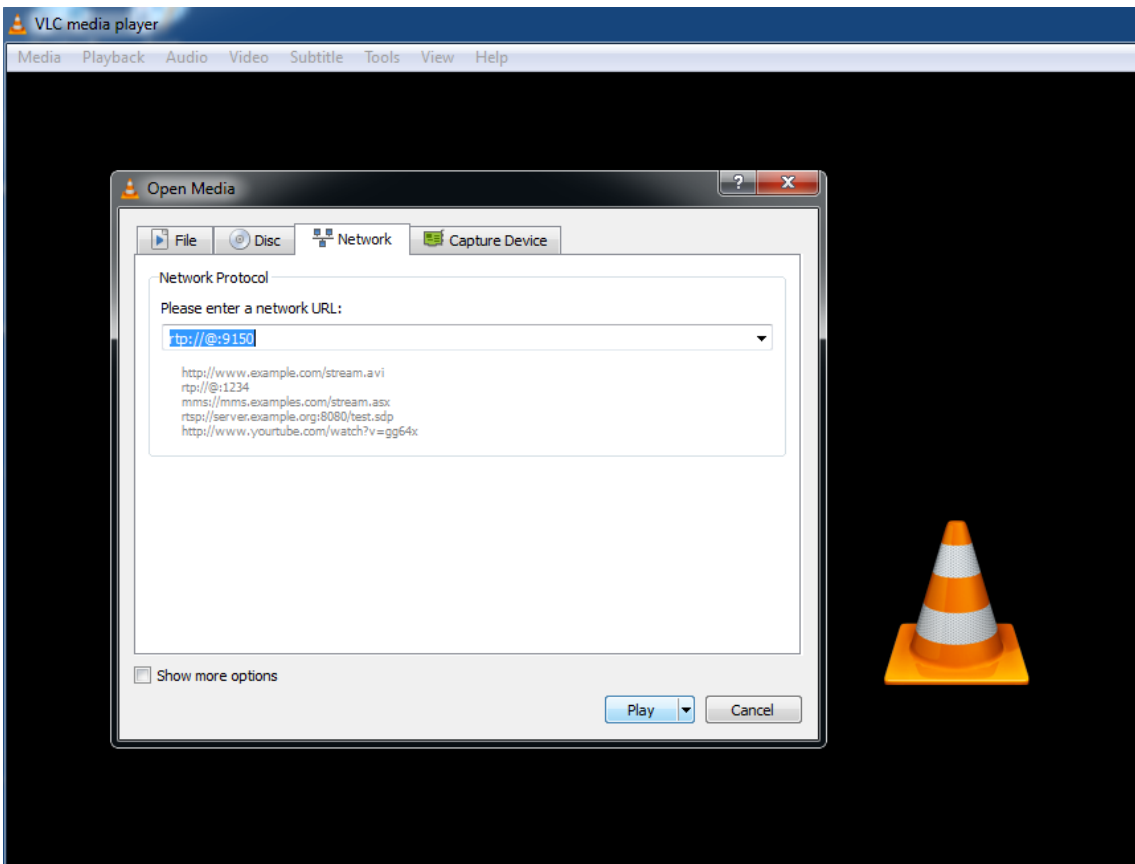
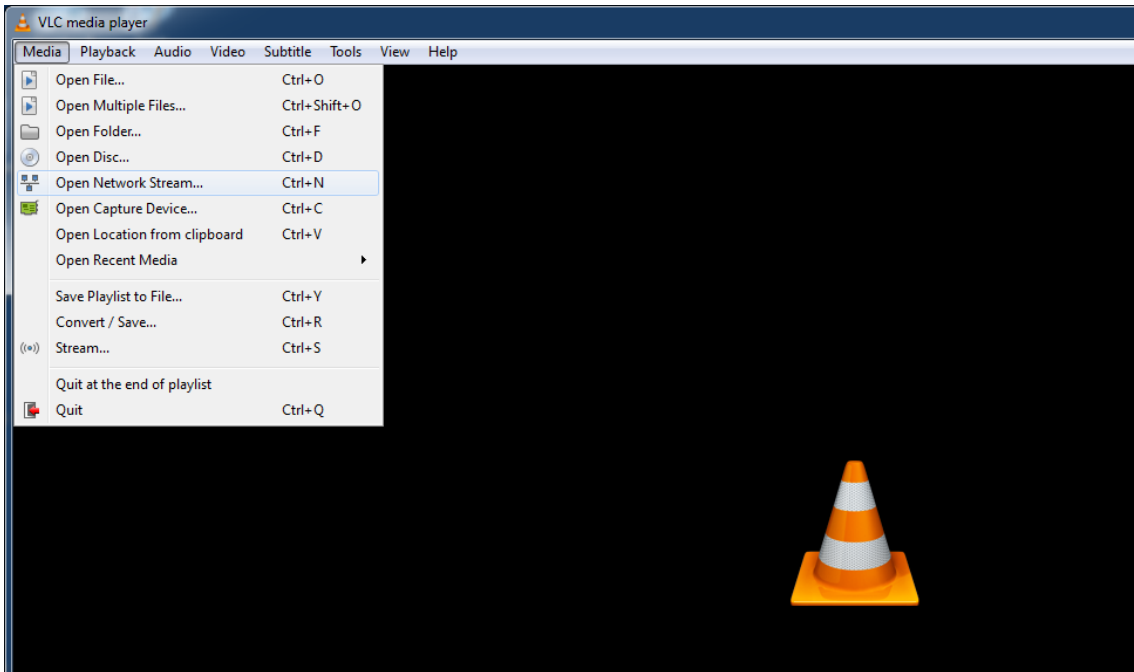



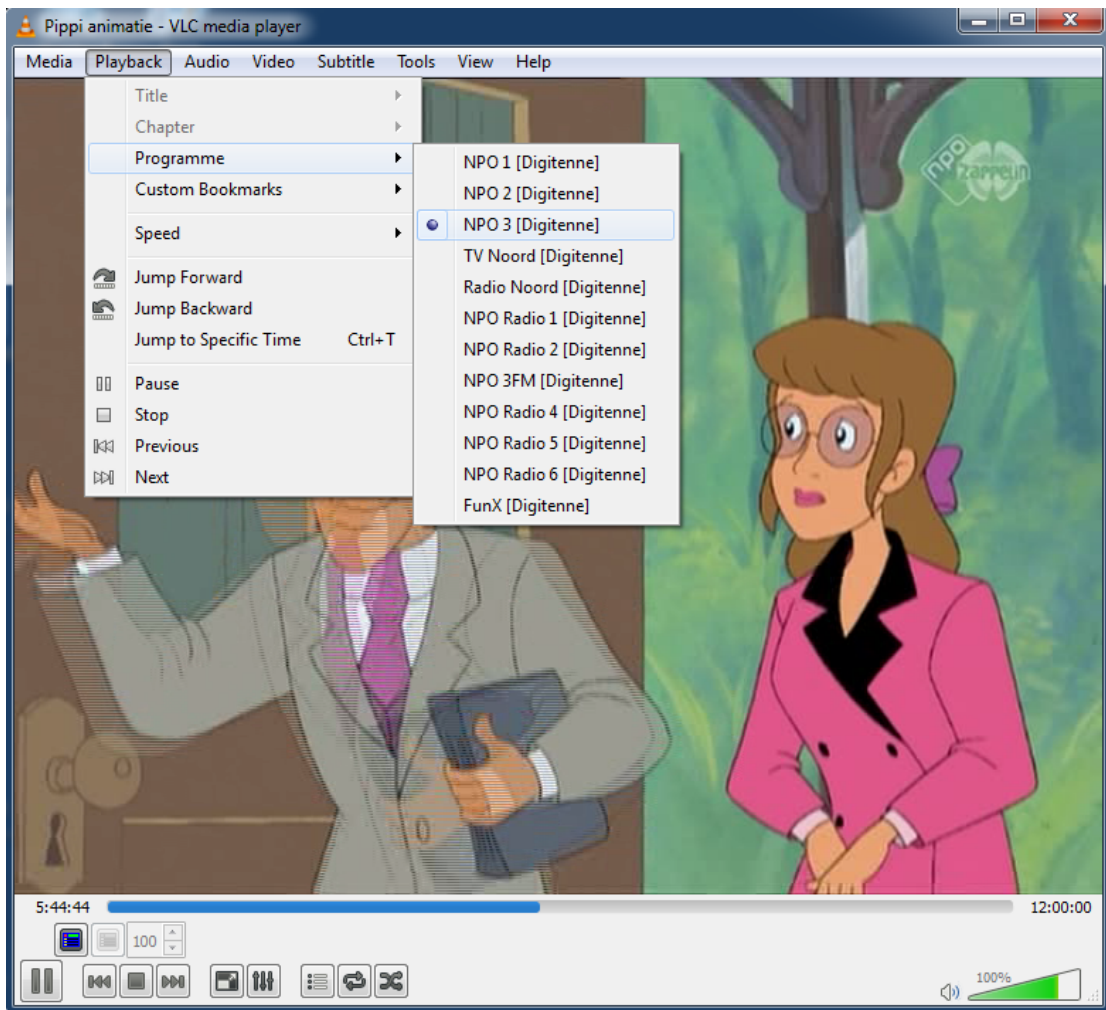

## Appedix1

DVB-IPI (ETSI TS 102 034) specifies protocols at the IP networking layer (IP Infrastructure) that must be supported on key system interfaces to deliver DVB services over IP networks.

Below are presented the main points on MPEG2 TS over IP Encapsulation set by DVB-IPI.

All MPEG-2 transport streams shall be encapsulated in RTP (Real-time Transport Protocol) according to RFC 1889 in conjunction with RFC 2250. Transport service is provided jointly by UDP (checksum and multiplexing) and RTP (sequencing and time stamping / jitter removing).

RTP always uses an even UDP port number.

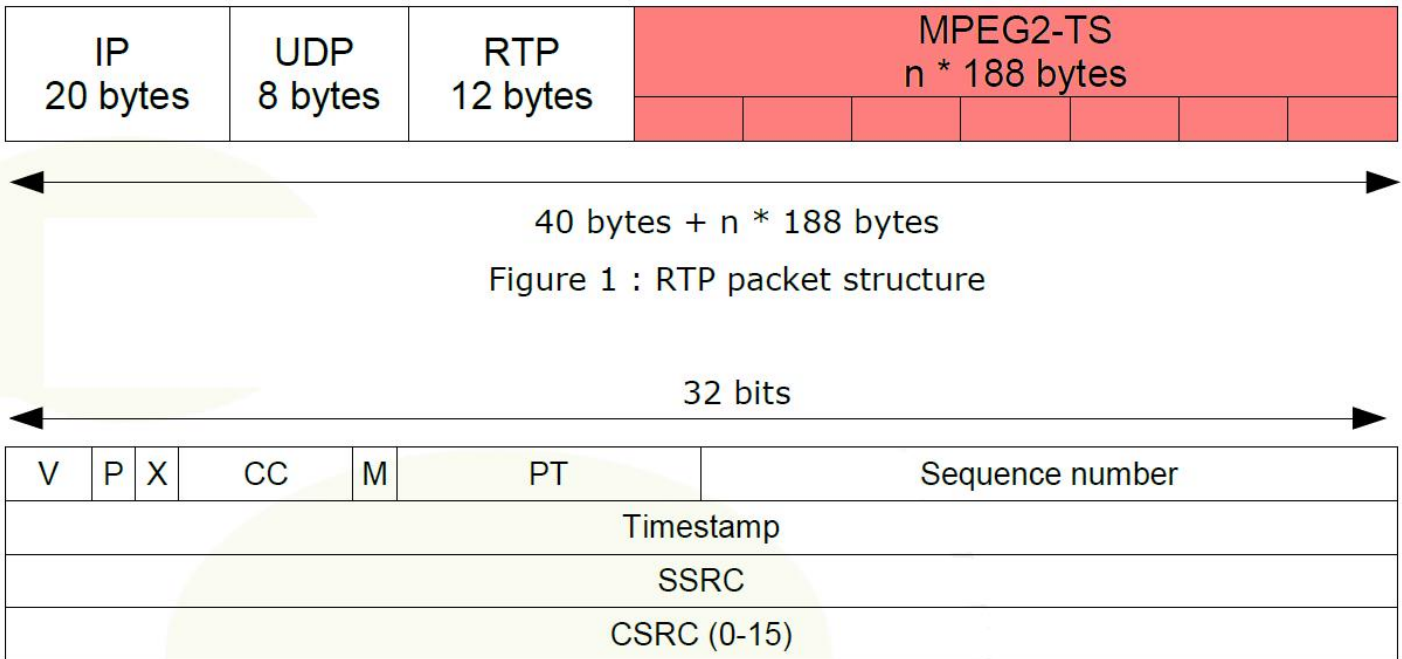

- V - Version, 2 bits. This field identifies the version of RTP.
- P - Padding, 1 bit. If the padding bit is set, the packet contains one or more additional padding bytes.
- X - Extension, 1 bit. If set, the fixed header is followed by exactly one header extension.
- CC - CSRC count. The CSRC count contains the number of CSRC identifiers that follow the fixed header.
- M - Marker, 1 bit. The interpretation of the marker is defined by a profile.
- PT - Payload type, 7 bits. Identifies the format of the RTP payload and determines its interpretation by the application.
- Sequence number Sequence number, 16 bits. The sequence number increments by one for each RTP data packet sent and may be used by the receiver to detect packet loss and to restore packet sequence.
- Timestamp Timestamp, 32 bits. The timestamps reflects the sampling instant of the first byte in the RTP data packet.
- SSRC Synchronization source, 32 bits. Identifies the synchronization source.
- CSRC Contributing source, 0 to 15 items, 32 bits each. An array of 0 to 15
- CSRC elements identifying the contributing sources for the payload contained in this packet.

For most streams, the RTP/UDP/IP overhead of 40 bytes per RTP packet is relatively low (for example 3% with a 1 316 byte payload).

IP packets can carry from 1 to 7 TS packets, knowing that:

- overall size of RTP payload must not exceed the MTU (Maximum Transfer Unit) in order to prevent RTP packets fragmentation around the network,
- short packets cause a high overhead.

There is no requirement for every RTP packet in a stream to contain the same number of transport stream packets. The receiver should use the length field in the UDP header to determine the number of transport stream packets contained in each RTP packet. The time stamp field in RTP header is based on the PCR values from MPEG-2 with a resolution of 90 Khz.

Streams must include PAT (Program Association Table) & PMT (Program Map Table) – other tables are optional. SI (Service Information) is intended to be delivered via separate IP streams, in e.g. XML format. RTCP (Real-time Transport Control Protocol) can be included to periodically inform the sending side about network quality (e.g. lost packets, delay, jitter, etc.).

The fact is that, at the output of the IP network, delivered Transport Stream must be fully ISO/IEC 13818-1 compliant (40ms maximum jitter, 1 artifact every hour...).

## Forward Error Correction

The Pro-MPEG Forum (association of broadcasters, program-makers, and vendors) approved an open standard to improve QoS in professional video over IP networks, while keeping interoperability between equipment manufacturers.

Standard is provided as a set of guidelines and recommendations (Codes of Practice).

Code of Practice #3 describes a Forward Error Correction (FEC) method for protection against errors in delivering professional MPEG-2 TS data over IP networks. This method implemented in IP adapters, packet errors, out of order packets, network jitter and delay can be compensated. Such process is done in real-time along with TS over IP encapsulation.

FEC protection data is calculated and embedded in regular RTP packets with a specific payload type, and relies on simple XOR arithmetic's (if  $F=A \oplus B \oplus C$ , then if only A,B,F are present, C can be recovered with  $C=A \oplus B \oplus F$ ). A FEC matrix is generated (cf figure 3) and transmitted on two separate UDP ports, FEC columns on UDP port + 2 and FEC rows on UDP port + 4.

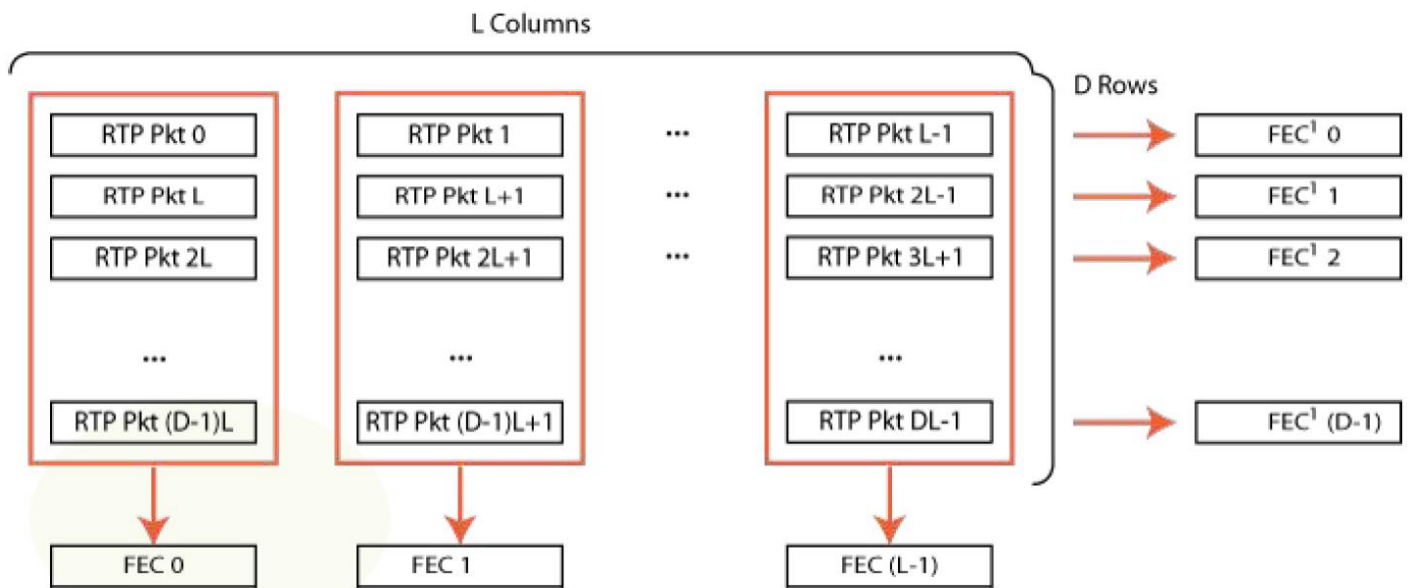

The dual FEC mode structure

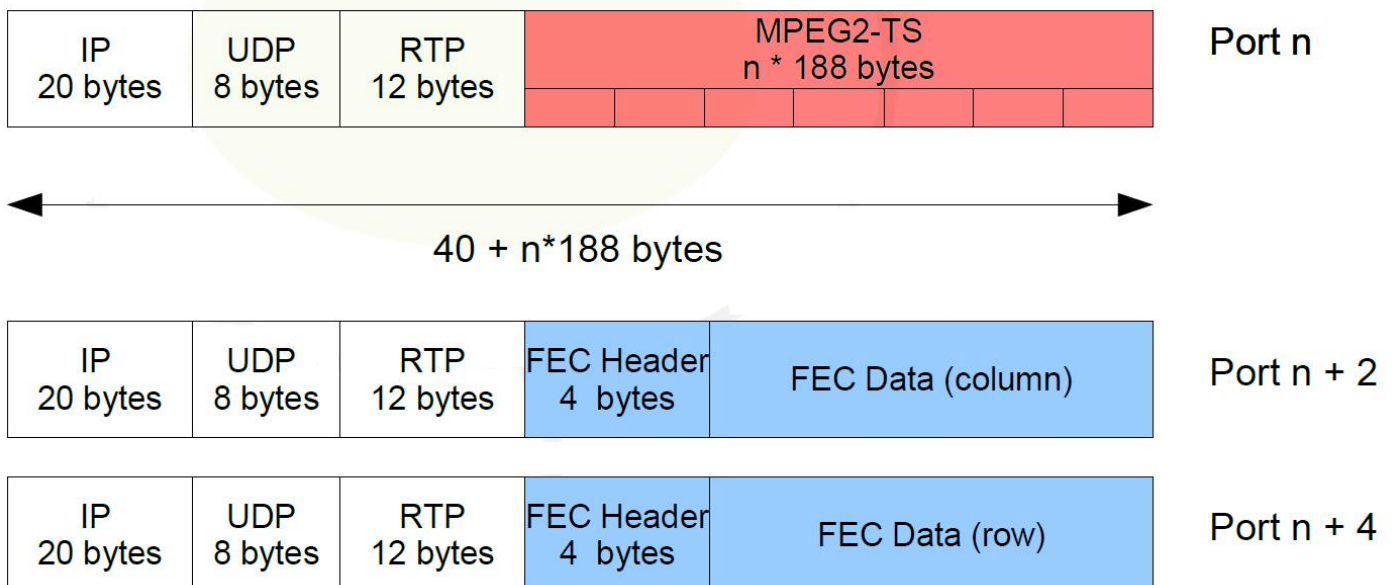

FEC packets transmission

Alitronika DVS continually strives to improve its products to keep up with ever increasing demands of the broadcasting industry.

Therefore Alitronika DVS reserves the right to make changes in its product specifications at any time without notice. The reader is cautioned to verify that the specification documents are current before placing orders.

Information furnished in this document is believed to be accurate and reliable.

However, Alitronika DVS assumes no responsibility for any errors that may appear in any of its documents. Furthermore, Alitronika DVS assumes no responsibility for the consequence of use of such information or for any infringement of patents or other rights of third parties that may result from its use. No license is granted by implication or otherwise under any patent or patent rights of Alitronika DVS.

This document supersedes and replaces all information previously supplied.

Alitronika DVS makes no warranty, representation or guarantee regarding the suitability of its products for any particular purpose, nor does Alitronika DVS assume any liability arising out of the application or use of any product and specifically disclaims any and all liability, including without limitation special, consequential or incidental damages. Conformity to standards, all operating parameters and compliance to regulations must be validated for each customer application by customer's technical experts.

Alitronika DVS products are not authorized for use as critical components in any systems such as life supporting systems.